



VMDSEMI

VUTP010R058NA

Datasheet



VMDSEMI

General Description

$V_{(BR)DSS}$	$R_{DS(ON)_{max}}$	I_D
100V	5.8mΩ@10V	200A

Symbol

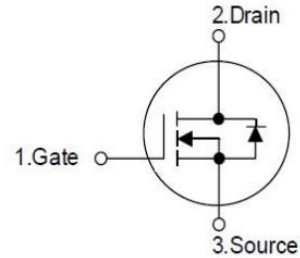

Figure 1 Symbol of VUTP010R058NA

Features

- Low $R_{DS(ON)}$
- Enhancement mode
- 100% Avalanche Tested
- Pb Free

Application

- PD charger
- Motor driver
- Switching voltage regulator
- DC-DC converter
- Switched mode power supply

Package Type

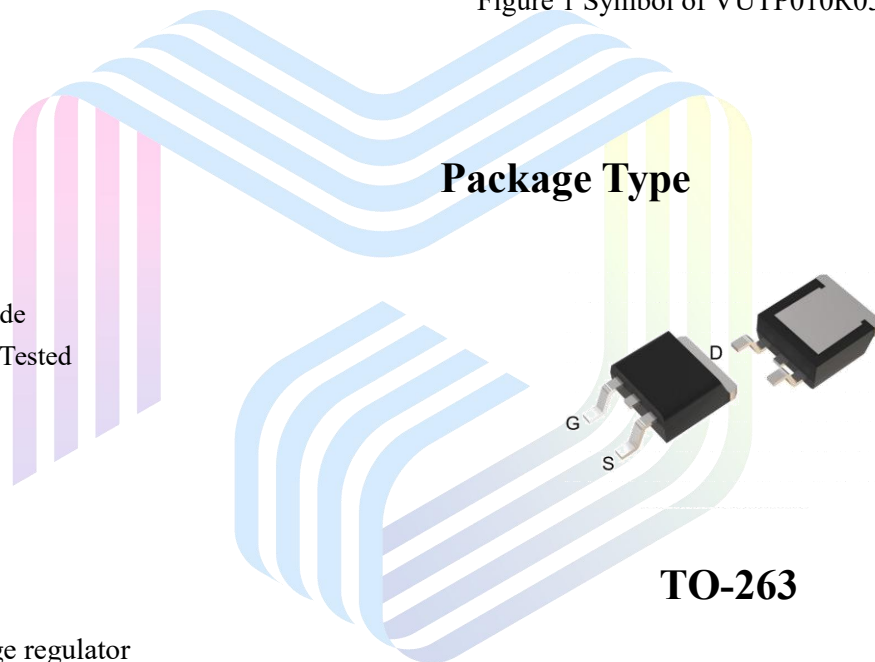

TO-263

Figure 2 Package Type of VUTP010R058NA

VMDSEMI

Ordering Information

Product Name	Package
VUTP010R058NA	TO-263

Absolute Maximum Ratings ($T_A=25\text{ }^\circ\text{C}$, unless otherwise specified)

Parameter		Symbol	Rating	Unit
Drain-Source Voltage		V_{DSS}	100	V
Gate-Source Voltage		V_{GSS}	± 25	V
Continuous Drain Current	$T_C=25^\circ\text{C}$	I_D	200	A
Continuous Drain Current	$T_C=100^\circ\text{C}$		142	
Pulsed Drain Current ^{Note 2}	$T_C=25^\circ\text{C}$	$I_{D,pulse}$	800	A
Continuous Diode Forward Current	$T_C=25^\circ\text{C}$	I_S	200	A
Continuous Drain Current	$T_A=25^\circ\text{C}$	I_{DSM}	15	A
Continuous Drain Current	$T_A=70^\circ\text{C}$		12	A
Max Power Dissipation	$T_C=25^\circ\text{C}$	P_D	375	W
Max Power Dissipation ^{Note 3}	$T_A=25^\circ\text{C}$	P_{DSM}	2	W
Avalanche Energy, Single Pulse ^{Note 4}		E_{AS}	900	mJ
Operation and storage temperature		T_J, T_{STG}	-55 to 175	$^\circ\text{C}$

Thermal Resistance

Parameter	Symbol	Min	Typ	Max	Unit
Thermal Resistance, Junction-to-Case	$R_{\theta JC}$		0.4	0.5	$^\circ\text{C/W}$
Thermal Resistance, Junction-to-Ambient	$R_{\theta JA}$		62.5	75	



Electrical Characteristics($T_J = 25\text{ }^\circ\text{C}$, unless otherwise specified)

Parameter	Symbol	Test Conditions	Min	Typ	Max	Unit
Statistic Characteristics						
Drain-Source Breakdown Voltage	BV_{DSS}	$V_{GS}=0V, I_D=250\mu A$	100			V
Zero Gate Voltage Drain Current	I_{DSS}	$V_{DS}=100V, V_{GS}=0V$			1	μA
Zero Gate Voltage Drain Current $T_J=125\text{ }^\circ\text{C}$		$V_{DS}=100V, V_{GS}=0V$			100	μA
Gate-Body Leakage Current	Forward	$I_{GSSF}, V_{GS}=25V, V_{DS}=0V$			100	nA
	Reverse	$I_{GSSR}, V_{GS}=-25V, V_{DS}=0V$			-100	
Gate Threshold Voltage	$V_{GS(TH)}$	$V_{DS}=V_{GS}, I_D=250\mu A$	2.5	3.1	3.6	V
Drain-Source On-Resistance ^{Note1}	$R_{DS(ON)}$	$V_{GS}=10V, I_D=80A$		4.6	5.8	mΩ
Drain-Source On-Resistance ^{Note1} $T_J=100\text{ }^\circ\text{C}$				6.2		
Gate resistance	R_G	$f=1\text{ MHz, Open drain}$	0.2	2.3	5	Ω
Dynamic Characteristics						
Input Capacitance	C_{ISS}	$V_{DS}=30V$	10480	13970	18580	pF
Output Capacitance	C_{OSS}	$V_{GS}=0V$	495	660	880	pF
Reverse Transfer Capacitance	C_{RSS}	$f=1\text{ MHz}$	370	495	660	pF
Turn-on Delay Time	$t_{d(on)}$	$V_{DS}=50V$		38		ns
Rise Time	t_r	$I_D=40A$		65		
Turn-off Delay Time	$t_{d(off)}$	$R_G=3\Omega$		125		
Fall Time	t_f	$V_{GS}=10V$		53		
Gate Charge Characteristics						
Gate to Source Charge	Q_{gs}	$V_{GS}=10V$		67	89	nC
Gate to Drain Charge	Q_{gd}	$V_{DS}=50V$		63	95	
Gate Charge Total	Q_g	$I_D=40A$		238	317	
Reverse Diode Characteristics						
Drain-Source Diode Forward Voltage	V_{SD}	$V_{GS}=0V, I_{SD}=80A$		0.9	1.2	V
Reverse Recovery Time	t_{rr}	$I_{SD}=40A, V_{GS}=0V$		44	88	ns
Reverse Recovery Charge	Q_{rr}	$di/dt=100A/\mu s$		80	160	nC

Notes:

- Pulse width $\leq 380\mu s$; duty cycle $\leq 2\%$.
- Repetitive rating; pulse width limited by max junction temperature.
- The power dissipation P_{DSM} is based on $R_{\theta JA}$ and $@T_J = 125\text{ }^\circ\text{C}$
- Limited by T_{Jmax} , starting $T_J = 25\text{ }^\circ\text{C}$, $L = 0.5\text{ mH}$, $R_G = 25\Omega$, $I_{AS} = 60A$, $V_{GS} = 10V$.

Typical Performance Characteristics

Figure 3: Typ. Output Characteristics

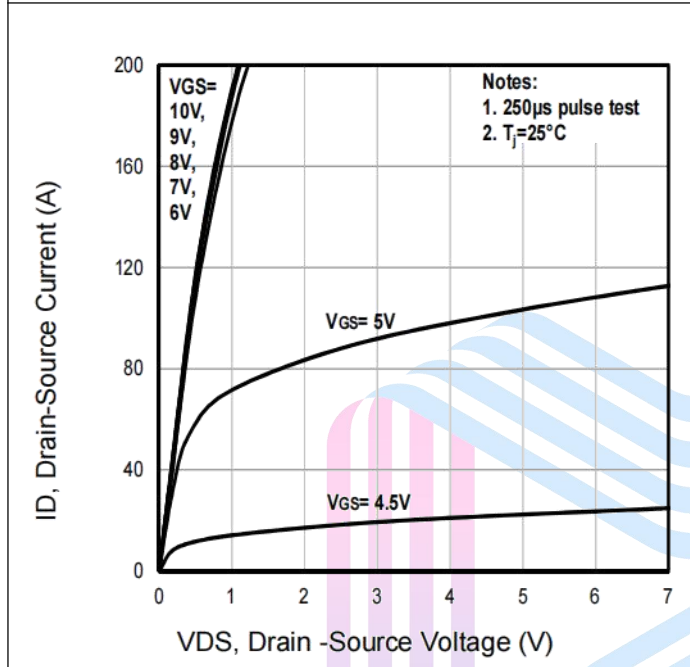

Figure 4: Typ. Gate Charge

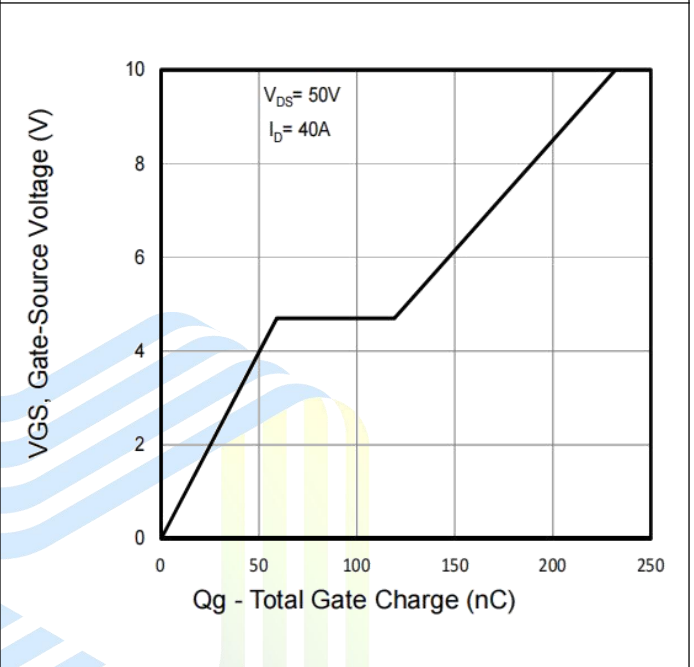

Figure 5: Normalized On-State Resistance

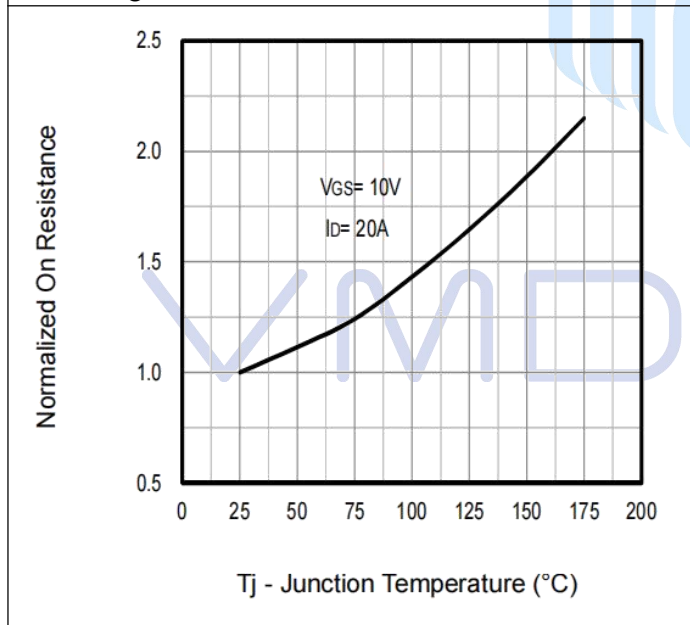

Figure 6: Typ. Transfer Characteristics

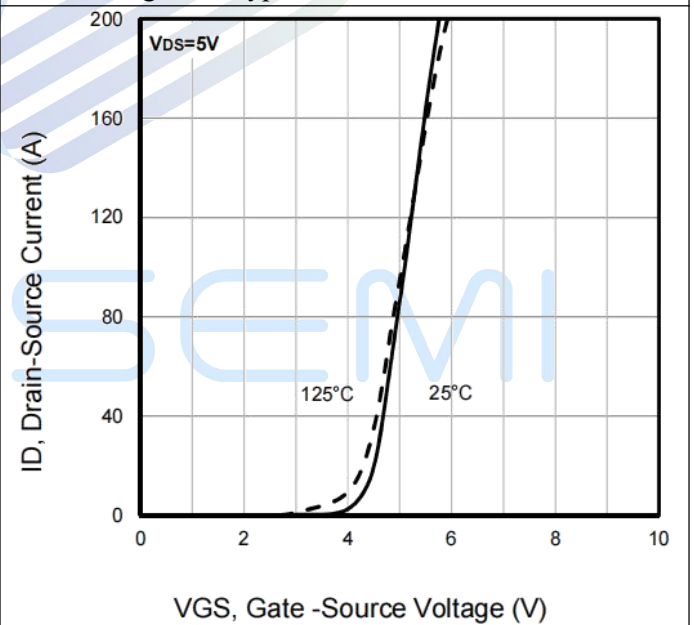

Figure 7: Typ. Capacitances

Figure 8: Forward Characteristics of Body Diode

Figure 9: Gate-Source Threshold Voltage

Figure 10: Safe Operating Area

Figure 11: Normalized Maximum Transient Thermal Impedance

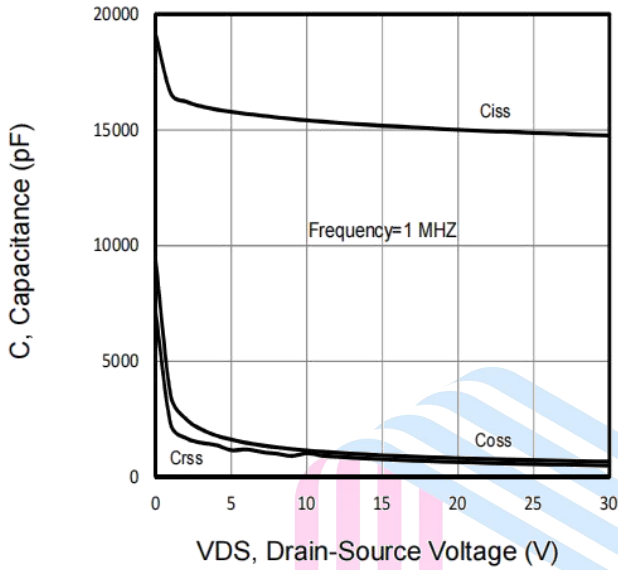
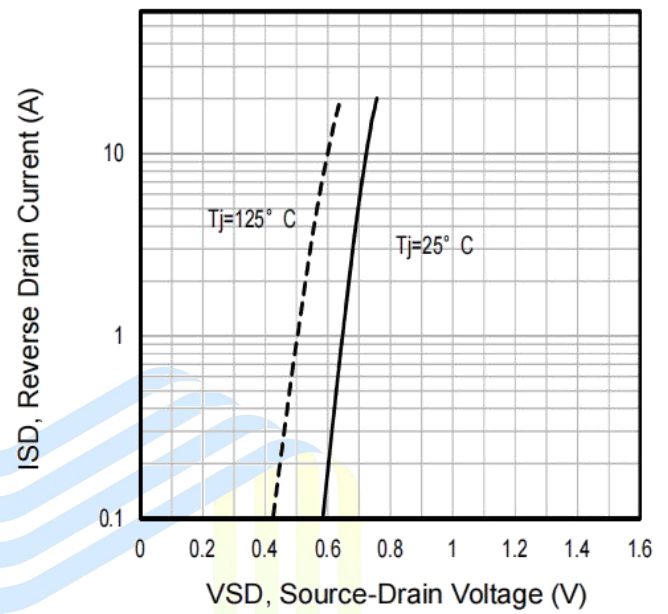
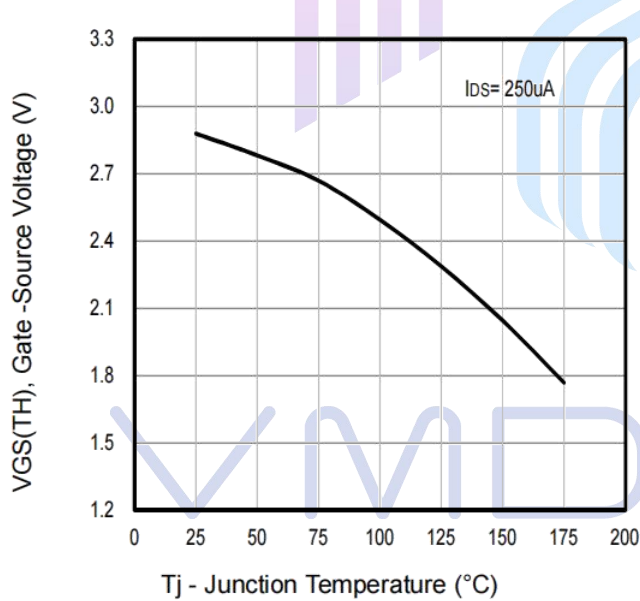
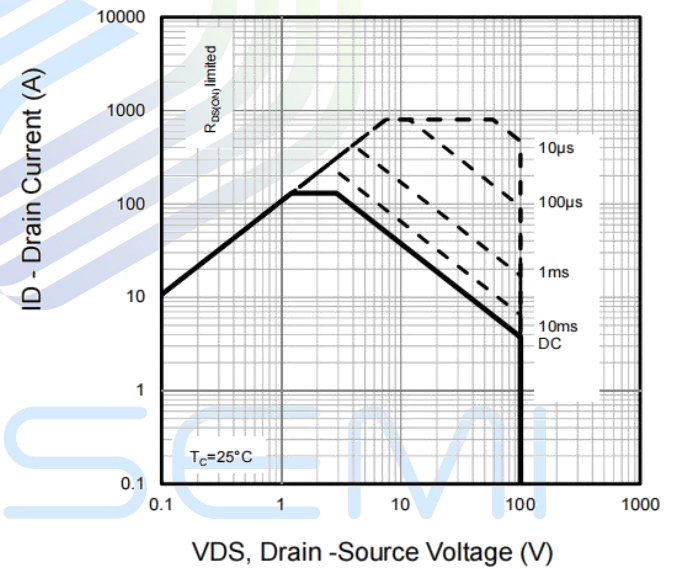
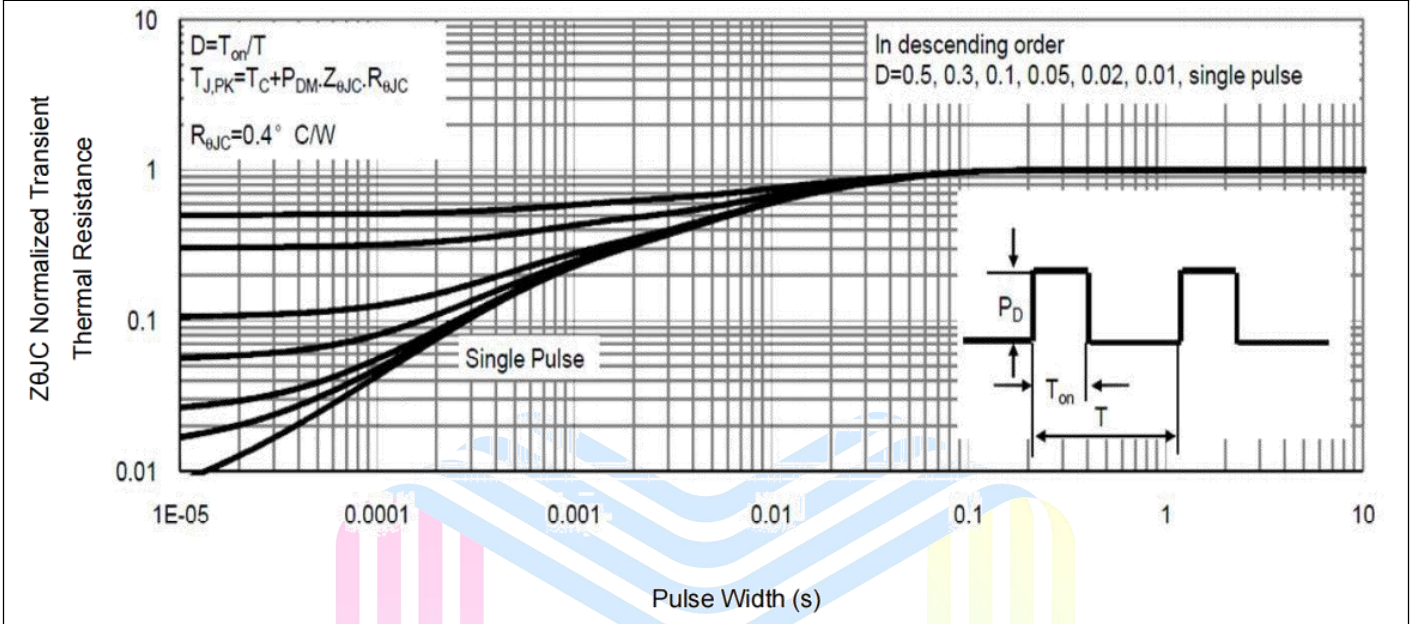
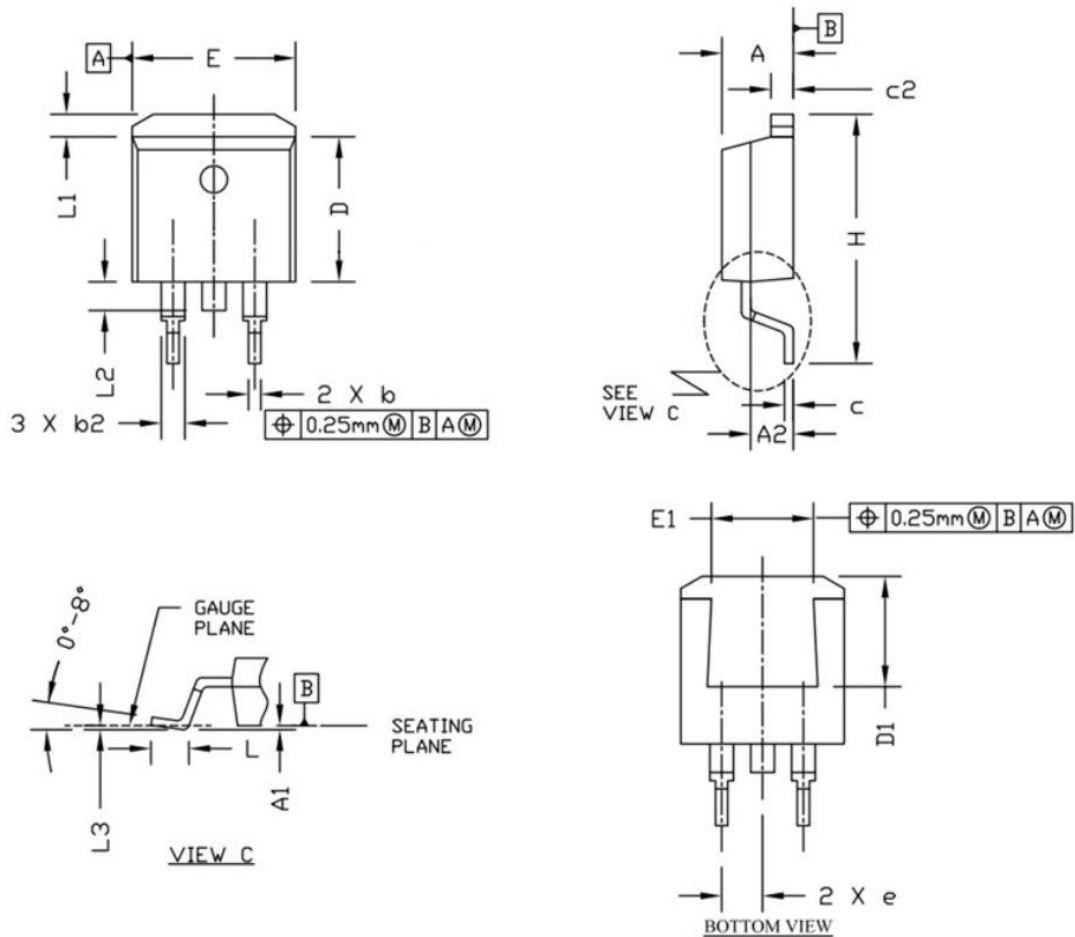

Mechanical Dimensions

Package Information TO-263



Symbol	Dimensions (unit: mm)		
	Min	Typ	Max
A	4.400	4.570	4.700
A1	0.000	0.100	0.200
A2	2.300	2.400	2.500
b	0.700	0.800	0.900
b2	1.200	1.270	1.360
c	0.381	0.500	0.737
c2	1.220	1.300	1.350
D	8.600	9.200	9.300
D1	6.860		
e	2.540 BSC		
E	9.780	9.880	10.260
E1	6.225		
H	14.700	15.100	15.500
L	2.000	2.550	2.750
L1	1.000	1.200	1.400
L2	1.300	1.600	1.700
L3	0.255 BSC		

Notes:

1. Refer to JEDEC TO-263 variation AB
2. Dimension "D" & "E" do NOT include mold flash, mold flash shall not exceed 0.127mm per side.

NOTICE

Hangzhou VMD Semiconductor Co., Ltd (VMD) reserves the right to make changes without notice in order to improve reliability, function or design and to discontinue any product or service without notice. Customers should obtain the latest relevant information before orders and should verify that such information is current and complete. All products are sold subject to VMD's terms and conditions supplied at the time of order acknowledgement.

VMD, its affiliates, agents, and employees, and all persons acting on its or their behalf, disclaim any and all liability for any errors, inaccuracies or incompleteness contained herein or in any other disclosure relating to any product.

VMD disclaims any and all liability arising out of the use or application of any product described herein or of any information provided herein to the maximum extent permitted by law. The product specifications do not expand or otherwise modify VMD's terms and conditions of purchase, including but not limited to the warranty expressed therein, which apply to these products.

VMD warrants performance of its hardware products to the specifications at the time of sale, testing, reliability and quality control are used to the extent VMD deems necessary to support this warrantee. Except where agreed upon by contractual agreement, testing of all parameters of each product is not necessarily performed.

VMD does not assume any liability arising from the use of any product or circuit designs described herein. Customers are responsible for their products and applications using VMD's components. To minimize risk, customers must provide adequate design and operating safeguards.

VMD does not warrant or convey any license to any intellectual property rights either expressed or implied under its patent rights, nor the rights of others. Reproduction of information in VMD's data sheets or data books is permissible only if reproduction is without modification or alteration. Reproduction of this information with any alteration is an unfair and deceptive business practice.

VMD is not responsible or liable for such altered documentation. Resale of VMD's products with statements different from or beyond the parameters stated by VMD for that product or service voids all express or implied warrantees for the associated VMD product or service and is an unfair and deceptive business practice.

All Rights Reserved.





Via-Media Semiconductor Limited Company

<http://www.vmdsemi.com>

Main Sites:

- Headquarters

Hangzhou Via-Media Semiconductor Co., LTD.
1305-1306, Building 71, No. 90, Wensan Road, Xihu
District, Hangzhou, Zhejiang Province, P.R. China
Tel: +86-0571-8515 0563

- Chengdu Office

Chengdu Winhi Semiconductor Co., LTD.
Floor 15, Building 5, No. 171, Hele 2nd Street,
Chengdu, Sichuan Province, P.R. China
Tel: +86-028-8505 0771

- Shanghai

Shanghai R&D Center.
1506~1508, Xinyin Building, 888 Yishan Road,
Shanghai, P.R of China
Tel: +86-021-54201999

- Shenzhen

Shenzhen Sales office
Room 4A15, Block AB, Tianxiang Building,
Chengongmiao, Futian District, Shenzhen, P.R of China
Tel: +86-0755-82570682

- Xi'an

Xi'an R&D Center
1703B, Building A, Greenland Center, Jinye Road,
High-Tech Zone, Xi'an, Shaanxi, P.R of China